



## RHCK1 Rabbit Hutch Complete Kit

### Features:

- Easy to clean, rust resistant galvanized steel construction
- Bottom panel with 1/2 x 1" spacing
- Side and top panels with 1 x 2" spacing
- Spring tension door latch
- Vinyl door guard
- Stackable frame kit
- Dropping pan
- Water bottle
- Feeder

### Each Rabbit Hutch Contains:

1 Bottom Panel	Guards	1 Feeder
1 Back Panel	1 Spring	1 Package Wire Clips
1 Front Panel	1 Door Latch	1 Wire Clip Pliers
1 Door Panel	4 Frame Legs	4 Bolts, washers, and nuts
2 Side Panels	2 Tray Brackets	
1 Top Panel	1 Dropping Pan	
4 Vinyl Door	1 Water Bottle	

### Tools Required:

- Wire Clip Pliers (see instructions at right)
- Wire Cutter
- Straight Blade Screwdriver
- Two 7/16" Wrenches

### Using the ACP2 Wire Clip Pliers:

1. Place ACC1 Wire Cage Clip in the pliers. See Figure 1.
2. Position clip next to wires to be fastened.
3. Close the pliers to form clips around wires  
**CAUTION:** Avoid pinching skin in pliers.

### Assembly Instructions:

**NOTE:** If you want to put the door on the left side of the front panel, reverse the position of the door and feeder hole shown.

1. Cut out a hole in the front panel for the feeder using a wire cutter. See Figure 2.
2. Lay out the hutch panels as shown in Figure 3. You can put the door on the right or left side of the front of the hutch.
3. Fasten a clip at each ●. Do not put clips where ○ appears.
4. Raise two adjoining panels so that they meet at the corner. Fasten clips at each ● shown in Figure 4. Repeat for the other corners.
5. Attach the door on the **inside** of the hutch using clips at each ● shown in Figure 5.
6. Slide the vinyl door guard over the edge of the door opening.
7. Place the top panel on top of the side panels. Fasten clips at each ● shown in Figures 6. Do not put clips where the ○ appears.
8. Install a frame leg at each ○ shown in Figure 7.  
**NOTE:** Wire clips cannot be used where the legs are to be installed. If necessary, remove any clips in these locations.
9. Ensure that the top wire of the side panel fits over the prongs on the legs as shown in Figure 7. If necessary, bend the prongs out slightly with a screwdriver. Install the bolts, washers, and nuts (finger tight only at this time).
10. Install the pan rails on the wide prongs as shown in Figure 7.
- 11a. When assembling one frame kit (not stacking hutches) complete the assembly by tightening the bolts, washers, and nuts for each leg.
- 11b. When assembling two frame kits (stacking hutches) proceed to step 12.
12. Install another set of legs beneath the first set as shown in Figure 8. Make sure the small tabs on the upper leg fit over the top of the lower leg. Install the bolts, washers, and nuts (finger tight only at this time).

### Assembly Instructions (continued):

13. Position the second hutch on the lower set of legs (another person is helpful when lowering the second hutch into position).
14. Install the pan rails on the wide prongs as shown in Figure 7.
15. Tighten all fasteners securely.
16. Install the feeder, water bottle, and dropping pan as shown in Figure 9.

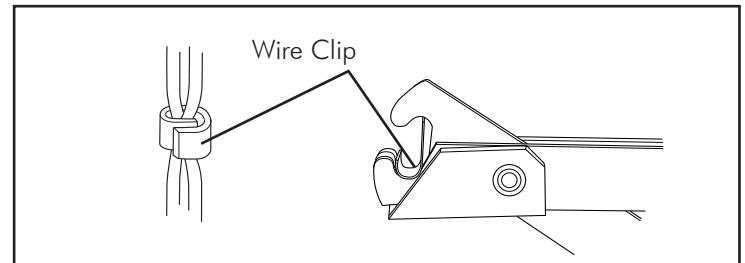

Figure 1

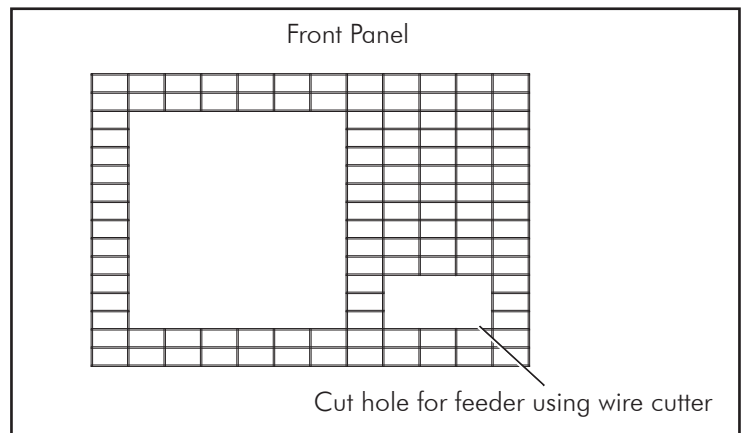

Figure 2

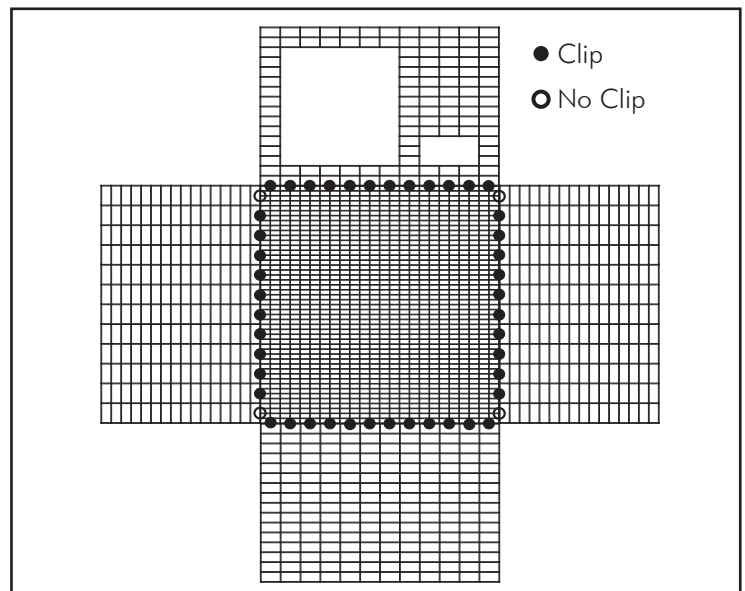
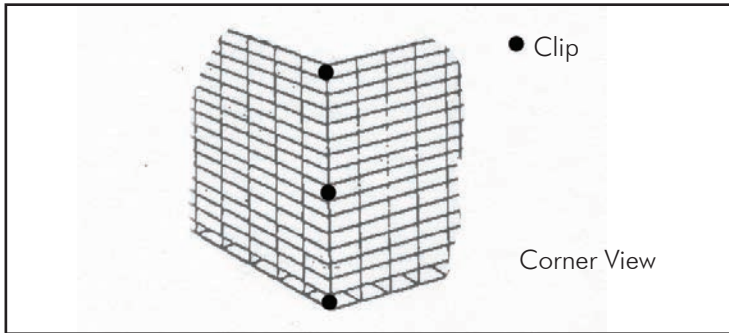
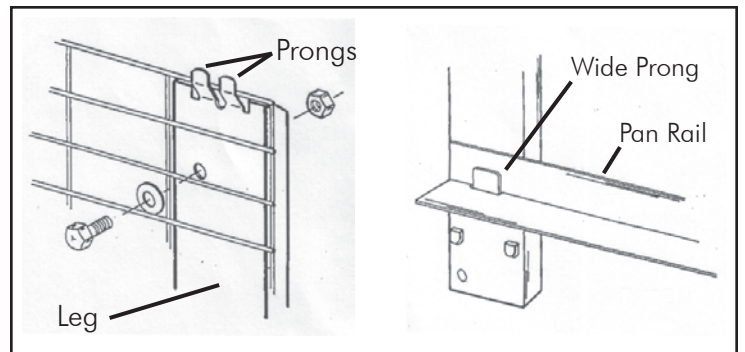

Figure 3



**Figure 4**



**Figure 7**

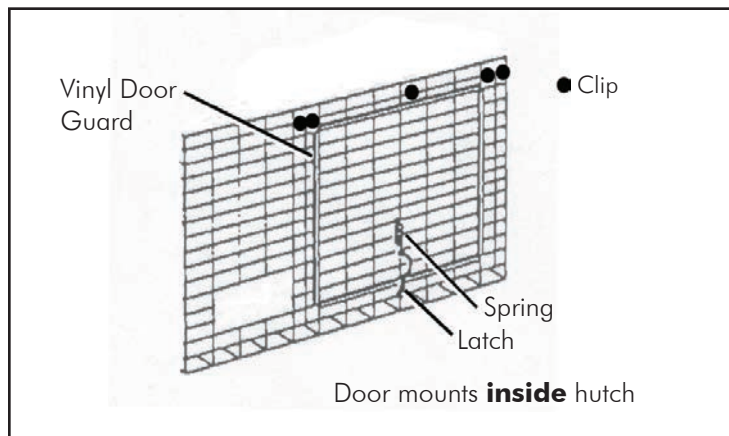

**Figure 5**

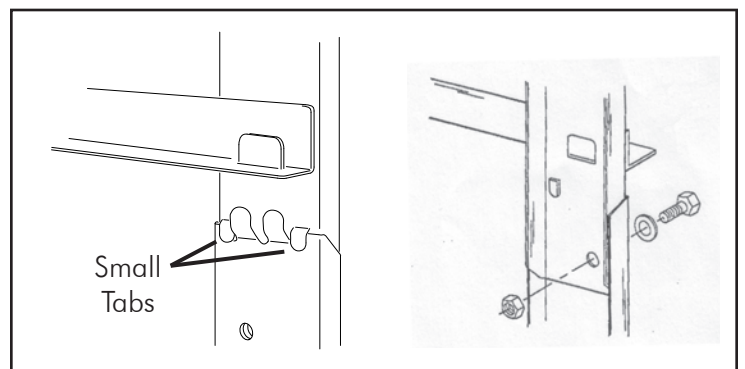

**Figure 8**

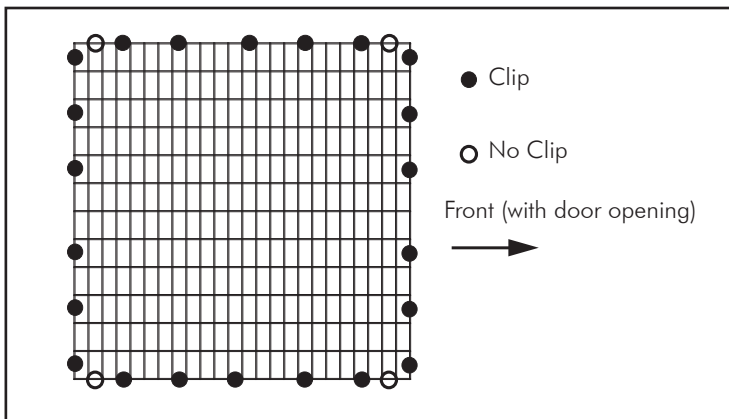

**Figure 6**

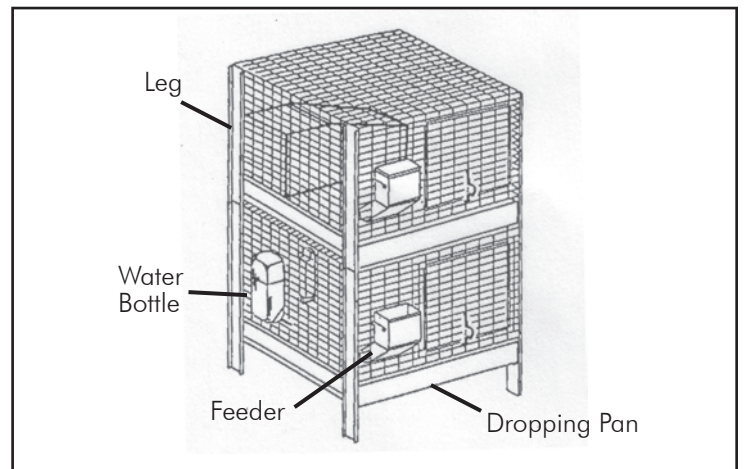

**Figure 9**

## Accessories

- Wire Cage Clips (ACC1)
- Wire Clip Pliers (ACP2)
- Small Animal Water Bottles (AW8, AW16, and AW32)
- Clear Series Water Bottles (CPB8, CPB16, and CPB32)
- Plastic Cage Cups (ACU1, ACU2, ACU4)
- Galvanized Cage Cup (ACU5)
- Salt Spool and Hanger (SSH2)
- Hay Rack (153171)
- Frame Kits (AHFK24, and AHFK30)

- Small Animal Feeders with metal bottom and lid (AF3ML, AF5ML, and AF7ML)
- Small Animal Feeders with sifter bottom (AF3S, AF5S, and AF7S)
- Small Animal Feeders with sifter bottom and lid (AF3SL, AF5SL, and AF7SL)
- Urine Guard Kits (AUG2424, AUG3030, and AUG3036)
- Galvanized Dropping Pans (ADP2424, ADP3030, and ADP3036)
- Plastic Dropping Pan (PDP2424)

**Miller Manufacturing Company**

1450 West 13th Street • Glencoe, MN 55336  
For more information visit [www.miller-mfg.com](http://www.miller-mfg.com)